

ECOLINE 230



23 M TRUCK-MOUNTED PLATFORM IN A NEW DRESS

YOUR REVENUE MAXIMIZER



EXCELLENT DIMENSIONS
IMPRESSIVE VERSATILITY

+ approx. 6,7 m total length und 2,9 m total height (depending on chassis-choice)

+ Can be mounted onto the latest chassis

+ 3,5 t-chassis with EURO 6

i Time-tested chassis to choose from!
Maximum versatility and easy handling

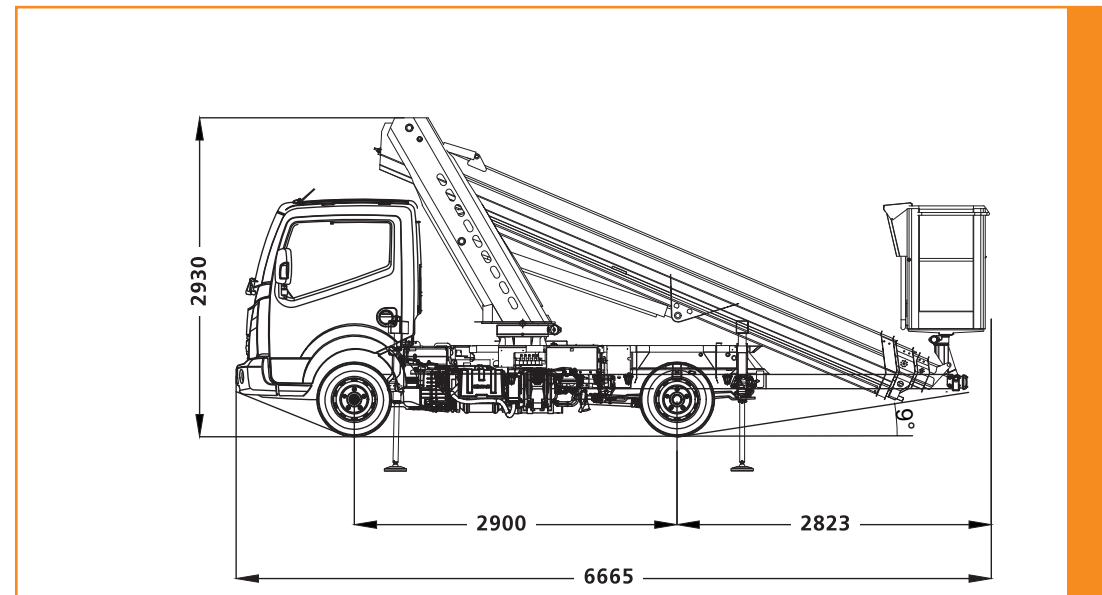
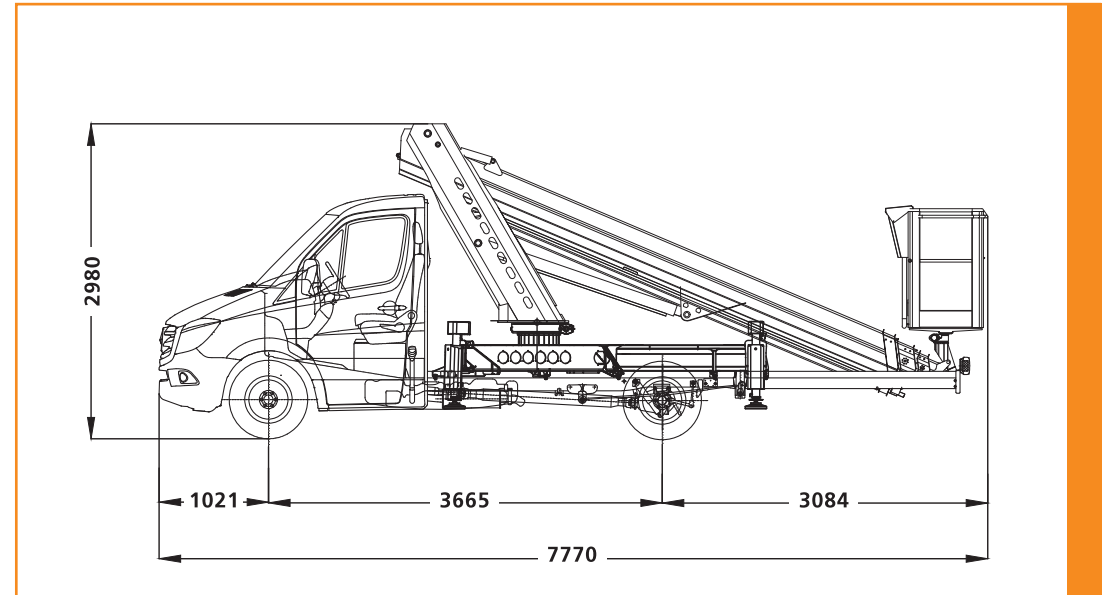

ECOLINE 230







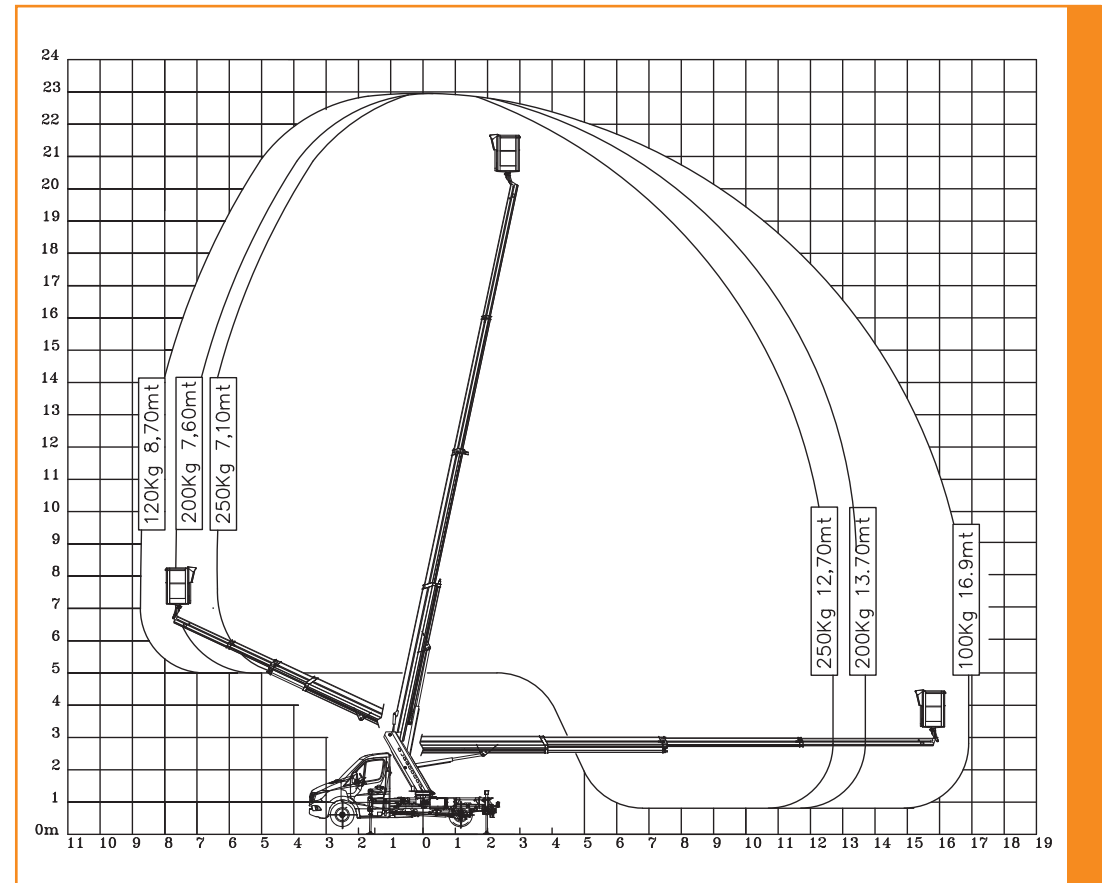



FASCINATING PERFORMANCE CAPABILITIES
IMPRESSIVE CAPACITY

- +** enormous lateral outreach to 17 m
- +** 23 m working height
- +** high loading capacity: 250 kg basket load



i **A real profit booster**

Amazing performance capabilities lead to higher rental income at lower acquisition and operating costs. The Ecoline 230 is the bona fide “profit booster” in your rental fleet.

	23,00 m		±90°		2,98 m
	16,90 m		1,30 m x 0,70 m		7,77 m
	360°		250 kg		3.500 kg xx,xxx t

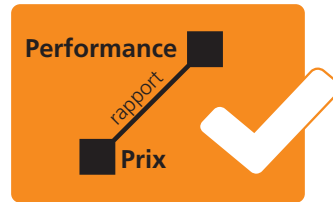

Premium technology and materials

TOP PRICE-PERFORMANCE RATIO

modern technology

- + RUTHMANN control panel (COCKPIT) as on STEIGER® models
Thanks to the same functionality, STEIGER series operators can also safely operate the ECOLINE 230 without any degree of difficulty ✓





tried-and-tested materials

- + multi-beveled boom fabrication
known from STEIGER® premium-segment ✓
- + high-strength, fine-grained steel
high stability and durability ✓
- + Steel truss fabrication on the tower
High torsional rigidity / stability ✓





EVEN MORE RUTHMANN-ENGINEERING

-  Upright entry using basket ladder
-  Convenient and safe access to work basket
-  Hydraulic 2 x 90° rotating basket
-  Indicator lights for safe and accurate stabilizing procedure





RUTHMANNSERVICE guaranteed

You can look forward to completely new and ultra-modern **RUTHMANN** engineering, along with **RUTHMANNSERVICE** and the excellent after-sales support, of course.





SUPPORT VARIATIONS CONVINCES WITH FLEXIBILITY

-  Variable stabilizing, also in cramped conditions (optional)
-  Modern HV (horizontal/vertical) stabilizing as on STEIGER® models
-  "Narrow" stabilizing possible within the contours of the vehicle



Versatility for everyone

The new ECOLINE 230 is very attractive for various target groups. The perfect all-rounder = enhanced utilization rate.

- painters
- cleaning agents
- tree-keeper
- roofers
- network operators
- communities
- fire protection engineers
- Elektro-Installateure
- etc.



Equipment variations AND TO TOP IT ALL OFF...

+ EASY-Stabilizing System: patented stabilizing system (serie)

By activating just one lever, the rear support unit is evenly extended to balance the longitudinal tilt of the vehicle. The second lever is activated to level the vehicle sideways.

+ Secondary Guarding System (optional)

The "Secondary Guarding System" prevents operators from becoming entrapped/crushed at the job site. The rubber switch strip placed in front of the control panel effects, as secondary protection system, an interruption of the movements of the aerial platform.











INGENIERIE  RUTHMANN



Ihre Vorteile



- top price-performance ratio
- enormous lateral outreach to 17 m
- high loading capacity: 250 kg basket load
- standardization of RUTHMANN control concept
- high-strength, fine-grained steel
- multi-beveled boom fabrication
- high-quality boom and tower construction
- EASY-Stabilizing System and Secondary Guarding System
- 3,5 t-chassis (EURO 6), multi-chassis compatible
- **RUTHMANNSERVICE** ...at its best!

	23,00 m		±90°		2,98 m
	16,90 m		1,30 m x 0,70 m		7,77 m
	360°		250 kg		3.500 kg